



Everything you've ever  
wanted under one roof

FANS CATALOGUE 2023

START NOW >

# ORIENT ELECTRIC

A BRAND THAT STRIVES TO BRING THE BEST OF INNOVATION FOR YOU.

## For you and the future that awaits you.

The pioneers of change. The market leaders. The Superbrand. We are known by a lot of names but at our core, we are a brand with a singular goal in mind - delighting our consumers with the finest there is to offer! And we've been doing it for 68 years.

Our customer-first ideology empowers us to break new barriers in our pursuit of offering better, more innovative solutions. We strive every day to get the right proportions of aesthetics, technology, and performance at your doorstep.

At Orient, your comfort and convenience take the front seat, with affordability and functional utility following suit. Which is one of the reasons why we're the front-runners in the energy-efficient fans segment. We are always in-sync with the changing rules of the modern world and constantly explore new avenues to make life simpler, better, and future-ready.

We are already India's favorite one-stop-shop for fans, lighting, home appliances, switchgears, and other electrical solutions. And yet, we're always excited for more - more innovations, more comfort, more elegance.

**We call it The Orient way.**

YEAR  
OLD  
LEGACY **68**



# BEE STAR RATING FOR CEILING FANS

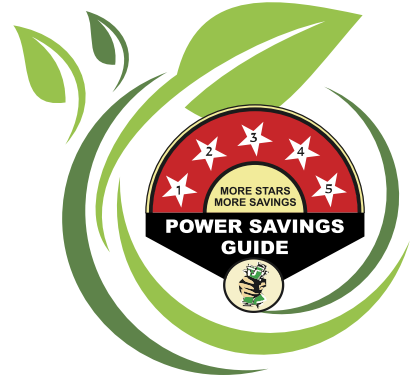

Did you know that in a tropical country like India, ceiling fans play an essential role in keeping households cool and comfortable? However, they can also consume a significant amount of energy, accounting for almost 20% of overall household electricity usage. That's why the Bureau of Energy Efficiency (BEE) has introduced a new BEE Star rating scheme for fans

Starting January 1st, 2023, all ceiling fans produced must comply with this rating scheme, and manufacturers must obtain relevant NABL testing to ensure their fans meet the standards. By choosing a BEE-compliant 5-star rated fan, you could save up to ₹1700 per year, and reduce your energy consumption by up to 50% compared to non-star rated traditional fans.

Happy to introduce our new BEE complied Star Rated ceiling fan series which are more energy-efficient and cost-effective option today. Stay cool, comfortable, and save big on your electricity bills with Orient Fans!

# SAVINGS ARE IN THE AIR! ORIENT STAR-RATED FANS.

How to calculate star-rating in fans?

Air Delivery / Watt = Service Value, further Service Value is designated as per BEE norms.

Slabs (Service Value)	Star Rating	Annual Savings (INR)*
≥4.0 < 4.5	1 Star	861
≥4.5 < 5.0	2 Star	1096
≥5.0 < 5.5	3 Star	1291
≥5.5 < 6.0	4 Star	1448
≥6.0	5 Star	1761

\*Orient fans compared to non star induction motor fans. Calculated basis electricity rates @₹6.7/unit



Redesigned motor for less power consumption



BEE Certification from NABL Approved Labs



Added safety wire

# STATE-OF-THE-ART FAN MANUFACTURING FACILITIES

Many of the Innovations in the fan industry that are now taken for granted came from the research of Orient Electric's R&D centres and from our urge to bring top-quality products to Indian consumers. As a brand leader as well as a thought leader in fans, we have been routinely introducing pioneering manufacturing processes and technologies thus setting new industry benchmarks in terms of performance, functionality, reliability, and aesthetics.

We draw a sizable advantage from our state-of-the-art proprietary manufacturing facilities for fans at Faridabad and Kolkata, which enables us to manufacture first-to-market products with best-in-class quality and performance. Quality being the key driving force behind everything we do at Orient Electric, we conscientiously follow the Six Sigma processes to manufacture zero-defect products.

Our sustained investments in building up competence and innovation centers have helped not only to bring differentiation but also bring down costs. We have a huge acceptability of our products in the international markets. We are today the largest exporter of fans from India with a strong marketing presence in over 35 international markets.



## ORIENT ELECTRIC MILESTONES

- |      |                                                                                                                     |      |                                                                           |
|------|---------------------------------------------------------------------------------------------------------------------|------|---------------------------------------------------------------------------|
| 1939 | The journey begins.<br>Factory established in Kolkata.                                                              | 2014 | Unveils energy-efficient BLDC fans.                                       |
| 1954 | Inducted into the CK Birla Group.<br>Renamed as Orient Fans.                                                        | 2016 | Unveils the 'Very Silent Very Powerful'<br>Aeroquiet premium ceiling fan. |
| 1965 | Becomes the first Indian company to<br>introduce die-casting of the rotor and<br>fan body cover in ceiling fans.    | 2017 | Demerges and gets listed as a<br>separate entity.                         |
| 1969 | Establishes a factory in Faridabad.                                                                                 | 2018 | Gets listed on the stock<br>exchanges.                                    |
| 1990 | Develops and patents the revolutionary<br>PSPO technology for fans.                                                 | 2019 | Unveils India's first smart ceiling fan.                                  |
| 2014 | Unveils new brand identity.<br>Rebranded as Orient Electric with the<br>positioning statement of 'Switch to Smart'. | 2020 | Enters the 'Fortune India 500' list.                                      |
|      |                                                                                                                     | 2023 | Launches first-of-its-kind Cloud 3 fan<br>with Cloudchill technology.     |

# ACCOLADES AS GLORIOUS AS OUR RANGE



At Orient Electric, we have a great story to tell. As an enduring enterprise, we have been creating value consistently for more than six decades. And we are honoured to have been recognised time and again for our accomplishments as a consumer electricals major, a great employer, and a responsible corporate citizen.

We continue to be a consumer validated 'Superbrand' for Fans, Air Coolers and Lighting. In the recent times, we have been conferred with many other illustrious awards and recognitions including Most Trusted Brands of India 2023, Prestigious Brands of Asia 2021-22, The Economic Times Iconic Brands of India 2022, and National Energy & Conservation Award 2021, just to name a few. We have been consistently awarded 'Star Performer' by the Engineering Export Promotion Council (EEPC) and are also rated as 'Star Export House' by the Ministry of Commerce and Industry, Government of India.

Additionally, we continue to retain our 'Great Place to Work' certification since 2020 which endorses our commitment to sustaining a high-performance, people-centric culture.

HOME

ABOUT US

PRODUCTS

CONTACT



Aero Series



Under Light Fans



BLDC Fans



Decorative Fans



Lifestyle Fans



Table, Pedestal & Wall Fans



Exhaust Fans

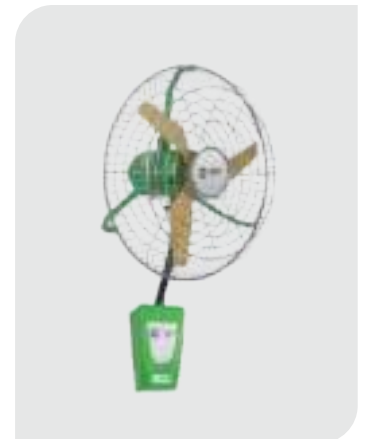

Industrial Fans

## Product Comparison

Model Sweep (MM), Speed (RPM), Air Delivery (CMM), Consumption (WATTS)





FEATURES

PRODUCTS

Introducing, the best of us for the best of you! Arriving in style with their trademark elegance and exclusive designs, Orient Aero Series fans are exceptional without a doubt.

# Aero Series

AERO SERIES



**VERY SILENT. VERY POWERFUL. VERY EFFICIENT.**

The Aero Series fans have many sides to them. They are bold, dynamic and premium. They also are technologically unmatched, governed by the core principle of aerodynamics applied in aircrafts and Formula One cars. This design and the use of new-age material reduce friction and air turbulence like never before. The result? Drastically reduced fan noise and an unmatched air thrust. So, wait no further. The coolness, the silence, the future await you.



**BEND AND  
RUST PROOF  
ABS BODY**



**HYDROGRAPHIC  
PU FINISH**



**ROBUST &  
RELIABLE  
INTELLIGENT  
BLDC MOTOR**



**HIGHEST  
AIR DELIVERY**



**AERODYNAMIC  
& SLIM DESIGN**



**CEILING  
ADJUSTABLE  
TELESCOPIC  
MOUNTING**

AERO SERIES



Aeroslim BLDC



Aeroquiet BLDC



Aeroquiet



Aerostorm



Aerolite



Aerocool

AERO SERIES

AEROSLIM BLDC



COMPARISON

IOT ENABLED

India's first-ever IoT enabled, voice-controlled ceiling fan.



High air delivery



3 Years warranty



Reverse rotation



Ceiling adjustable telescopic mounting



Aerodynamic and slim design



Bend & rust-proof ABS body

Sweep (mm)	Air Delivery (cmm)	RPM	Power (W)
1200	260	310	40

On using four fans for 16 hours daily throughout one year.

save upto ₹7000 annually\*



orient BLDC FANS

AERO SERIES

AEROQUIET BLDC



Mystic Gold



White



Daytone Grey



Caramel Brown



Matt Black

COMPARISON

**5 YEARS**  
**WARRANTY**



High air delivery



Aerodynamic & slim design



Very silent operation



Superior PU finish

Sweep (mm)	Air Delivery (cmm)	RPM	Power (W)
1200	225	310	35

On using four fans for 16 hours daily throughout one year.

save upto ₹7000 annually\*



orient  
BLDC FANS

AERO SERIES

AEROQUIET



Wooden

COMPARISON



White



Roasted Coffee



Caramel Brown



Mystic Gold



Matt Black



Daytone Grey



Orbes White



High air delivery



Strongest motor (18 pole)



Superior PU finish



Aerodynamic & slim design

Sweep (mm)	Air Delivery (cmm)	RPM	Power (W)
900	150	430	48
1200	225	310	55



900mm comes only in two colors Caramel Brown and White.

AERO SERIES

AEROSTORM

COMPARISON



High air delivery

Superior PU finish

Strongest motor (18 pole)

Aerofoil design

Aerodynamic & slim design

Sweep (mm)	Air Delivery (cmm)	RPM	Power (W)
1320	300	300	75

AERO SERIES

AEROLITE



COMPARISON



High air delivery



Warm white LED light



Superior PU finish



Aerodynamic & slim design

Sweep (mm)	Air Delivery (cmm)	RPM	Power (W)
1200	230	310	62



AERO SERIES

AEROCOOL

COMPARISON



High air delivery



Superior PU finish



Strongest motor (18 pole)



Aerofoil design



Aerodynamic and slim design

Sweep (mm)	Air Delivery (cmm)	RPM	Power (W)
1360	300	300	75



PRODUCTS

Air-circulating Luxury Chandeliers. Impeccable beauty, Impactful technology.

# Underlight Fans

UNDERLIGHT FANS



Ez01



Ez02



Aeroslim



Aerolite



Subaris



Subaris Solo



Woodwind



Spectra

UNDERLIGHT FANS

COMPARISON



Eleganza  
**EZ 01**  
AIR CIRCULATOR



Eleganza  
**EZ 02**  
AIR CIRCULATOR



Mood lighting  
(White, Yellow, Mix)



With Remote



High quality  
crystals



Provides  
Air Circulation



2 Years Warranty  
on Motor



Designer transparent  
retractable blades

UNDERLIGHT FANS

AEROSLIM BLDC



COMPARISON

**IOT**  
ENABLED

India's first-ever IoT enabled, voice-controlled ceiling fan.



Available with Remote



High air delivery



Robust and reliable BLDC motor



Reverse rotation



Ceiling adjustable telescopic mounting



Aerodynamic and slim design



Bend & rust-proof ABS body

Sweep (mm)	Air Delivery (cmm)	RPM	Power (W)
1200	260	310	40

\*On using four fans for 16 hours daily throughout one year.

save upto ₹7000 annually\*



orient  
BLDC FANS

UNDERLIGHT FANS

AEROLITE



Caramel Brown



White



High air delivery



Warm white LED light



Superior PU finish



Aerodynamic & slim design

Sweep (mm)	Air Delivery (cmm)	RPM	Power (W)
1200	230	310	62

COMPARISON

UNDERLIGHT FANS

SUBARIS



Motor Antique Brass  
Blade Oakwood



Motor Antique Copper  
Blade Oakwood

COMPARISON



5 Blades for high air delivery



Capacitor based speed control



Wooden-finish aluminium blades



Trendy glass shade for light



Electroplated finish for premium look



Reverse rotation

Sweep (mm)	Air Delivery (cmm)	RPM	Power (W)
1300	270	270	80

UNDERLIGHT FANS

SUBARIS SOLO

COMPARISON



Motor Brushed Nickel  
Blade Walnut



Motor Brushed Copper  
Blade Walnut



5 Blades for high air delivery



Capacitor based speed control



Wooden-finish aluminium blades



Trendy glass shade for light



Electroplated finish for premium look



Reverse rotation

Sweep (mm)	Air Delivery (cmm)	RPM	Power (W)
1300	270	270	80



UNDERLIGHT FANS

**WOODWIND**

COMPARISON



Metallic Bronze



5 Blades for high air delivery



Capacitor based speed control



Wooden-finish aluminium blades



Trendy glass shade for light



Elegant metallic bronze paint finish for a premium look



5 wooden blades with different wooden finish on both sides, to suit the home decor

Sweep (mm)	Air Delivery (cmm)	RPM	Power (W)
1300	215	250	80

UNDERLIGHT FANS

SPECTRA

COMPARISON



Antique Copper



Pewter Finish



Brushed Brass



LED light kit



LED light intensity adjustment as per need



Electroplated finish



Multi colour lights for different moods



Timer & 5-speed control through remote



Automatic and manual colour changing mechanism for lights



Multi-Colour Light Display

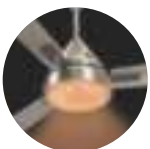

Candle Light



Green Light



Red Light



Yellow Light



Blue Light

Sweep (mm)	Air Delivery (cmm)	RPM	Power (W)
1200	230	320	70

# Energy Saving Series

In Brushless Direct Current motors, permanent magnets are used for transferring electricity unlike conventional motors that use electromagnetic induction. This means negligible losses in the form of heat along with lesser wear and tear of motor parts, making it super energy-efficient and durable. This is why it is widely being used in aircrafts, automobiles, home appliances, air conditioners, and washing machines.

## orient BLDC FANS

The BLDC fans series is a masterpiece of innovation, created to save energy and your hard-earned money. Its intelligent design is a result of years of research, which ensures that you never have to compromise. Apart from savings on your electricity bill, it also helps cut down CO2 emission by reducing consumption of coal for energy generation.



FEATURES

PRODUCTS

# Reason to switch to Orient BLDC FANS

Orient BLDC fans, powered by BLDC technology, provide increased durability of the motor, reduced motor noise and double the efficiency of operation, along with impressive savings on electricity bills.



Up to 50% Energy Saving



Low Noise Operation



Powerful Air Delivery



Works on Low Voltage

BDLC FANS



Aeroslim BLDC



Aeroquiet BLDC



i-Float BLDC IoT



i-Float BLDC



Hector-500 BLDC



i-Falcon Remote BLDC



i-Falcon BLDC



i Falcon Deco BLDC



Hector Deco BLDC



Ecotech Supreme BLDC



Ecotech Pro BLDC



Ecotech Prime BLDC



Jazz BLDC



Wendy BLDC

BDLC FANS

AEROSLIM BLDC



COMPARISON

**IOT**  
ENABLED

India's first-ever IoT enabled, voice-controlled ceiling fan.

High air delivery

3 Years warranty

Reverse rotation

Ceiling adjustable telescopic mounting

Aerodynamic and slim design

Bend & rust-proof ABS body



Sweep (mm)	Air Delivery (cmm)	RPM	Power (W)
1200	260	310	40

\*On using four fans for 16 hours daily throughout one year.

save upto ₹7000 annually\*



orient  
BLDC FANS

BLDC FANS

AEROQUIET BLDC



COMPARISON

5 YEARS WARRANTY



High air delivery



Aerodynamic & slim design



Very silent operation



Superior PU finish



Available with Remote

Sweep (mm)	Air Delivery (cmm)	RPM	Power (W)
1200	225	310	35

\*On using four fans for 16 hours daily throughout one year.

save upto ₹7000 annually\*



orient BLDC FANS

BDLC FANS

i-FLOAT BLDC IoT



Cosmos Black



White



Lakeside Brown



Space Grey

COMPARISON



Fan scheduling  
(start & stop as per your needs)  
Turbo mode, Sleep mode, Breeze mode  
Built-In Timer (2, 4, 6, 8 Hrs)

Aerodynamic design for 15% more air delivery

3 Years warranty

Reverse rotation

Works on low voltages (140V-270V)

Metalised decorative ring adds elegance and beauty

Very silent operation

Available with Remote

Sweep (mm)	Air Delivery (cmm)	RPM	Power (W)
1200	215	330	32

\*On using four fans for 16 hours daily throughout one year.

save upto ₹7000 annually\*



orient BLDC FANS



BDLC FANS

i-FLOAT BLDC



White



Cosmos Black



Lakeside Brown



Space Grey

COMPARISON

**3** 3 Years warranty

Metalised decorative ring adds elegance and beauty

Aerodynamic design for 15% more air delivery

Works on low voltages (140V-270V)

Saves up to 50% electricity

Very silent operation

Sweep (mm)	Air Delivery (cmm)	RPM	Power (W)
1200	215	330	32

\*On using four fans for 16 hours daily throughout one year.

save upto ₹7000 annually\*



orient BLDC FANS

BLDC FANS

HECTOR-500 BLDC



Topaz Gold



Brown



White



Pearl White

COMPARISON

**5 YEARS**  
**WARRANTY**



High air delivery



Very silent operation



Saves up to 50% electricity



Works on low voltages (140V – 270V)



Remote control for ease of operation



Robust & reliable Intelligent BLDC motor



Available with Remote

	Sweep (mm)	Air Delivery (cmm)	RPM	Power (W)
With Remote	1200mm	230	350	28
With Regulator	1200mm	230	350	32
	900mm	140	450	25
	1400mm	260	300	35

save upto ₹7000 annually\*



orient  
BLDC FANS

\*On using four fans for 16 hours daily throughout one year. 5 Years warranty available with 1200mm variant only.

BLDC FANS

i-FALCON Remote BLDC



COMPARISON



High air delivery



3 Years warranty



Very silent operation



Saves up to 50% electricity



Wide Tip Aluminium blades for better air spread.



Modern look with minimalistic design

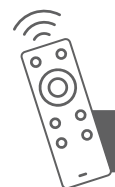

Available with Remote

Sweep (mm)	Air Delivery (cmm)	RPM	Power (W)
1200	225	350	32

\*On using four fans for 16 hours daily throughout one year.

save upto ₹7000 annually\*



orient BLDC FANS

BDLC FANS

i-FALCON BLDC



COMPARISON

 Robust & reliable Intelligent BLDC motor

 Saves up to 50% electricity

 3 Years warranty

 Works on low voltages (140V-270V)

 Noiseless Operation

Sweep (mm)	Air Delivery (cmm)	RPM	Power (W)
1200	225	350	30

\*On using four fans for 16 hours daily throughout one year.

save upto ₹7000 annually\*



orient BLDC FANS

BDLC FANS

i FALCON DECO BLDC



Brown



White

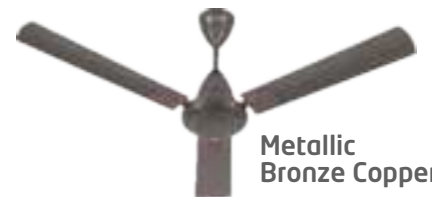

Metallic Bronze Copper

COMPARISON



Stylish and Elegant Design to enhance your home decor



Wide Tip Aluminium blades for better air spread.



Low noise operation



Works on Low Voltage(140-270V)



3 Years warranty



High air delivery



Available with Remote

Sweep (mm)	Air Delivery (cmm)	RPM	Power (W)
1200	225	350	30

\*On using four fans for 16 hours daily throughout one year.

save upto ₹7000 annually\*



orient BLDC FANS

BLDC FANS

HECTOR DECO BLDC



Brown



Royal Manioca



Metallic Bronze Copper



White

COMPARISON

**5 YEARS**  
**WARRANTY**



Low noise operation



Wider Tip Blade for better air spread



Stylish and Elegant Design to enhance your home decor



Remote Operation



Available with Remote

Sweep (mm)	Air Delivery (cmm)	RPM	Power (W)
1200	230	350	30

\*On using four fans for 16 hours daily throughout one year.

save upto ₹7000 annually\*



orient  
BLDC FANS

BDLC FANS

ECOTECH SUPREME BLDC



Wooden



Metallic Bronze Copper



Brown



White



Topaz Gold

COMPARISON



 Stabilizer free functioning (120V – 280V)

 Intelligent BLDC – 50% energy savings

 3 Years warranty

 Modern look with minimalistic design

 Remote Operation



Sweep (mm)	Air Delivery (cmm)	RPM	Power (W)
1200	220	370	28

\*On using four fans for 16 hours daily throughout one year. Also available in regulator variant with 30W power consumption.

save upto ₹7000 annually\*



orient BLDC FANS

BDLC FANS

ECOTECH PRO BLDC



Topaz Gold



White



Metallic Bronze Copper

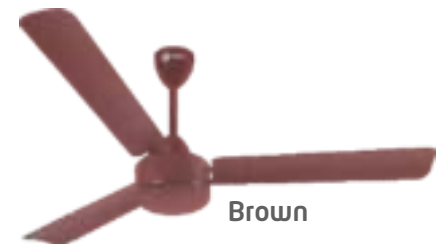

Brown

COMPARISON

Low Power consumption of 26W

Wider tip blades for High air delivery, 220CMM

3 Years warranty

Low Noise, silent operation

Advanced Intelligent BLDC Technology, results 50% Electricity Saving.

Available with Remote

Sweep (mm)	Air Delivery (cmm)	RPM	Power (W)
1200	220	370	26

\*On using four fans for 16 hours daily throughout one year. Also available with regulator with power consumption of 32W.

save upto ₹7000 annually\*



orient BLDC FANS



BLDC FANS

ECOTECH PRIME BLDC



Metallic Bronze Copper



White



Brown



Oakwood

COMPARISON

**HIGH SPEED**

 Stabilizer free functioning (120V – 280V)

 Modern look with minimalistic design

 3 Years warranty

 50% energy savings

 High air delivery

 Available with Remote

Sweep (mm)	Air Delivery (cmm)	RPM	Power (W)
1200	220	350	32

\*On using four fans for 16 hours daily throughout one year.

save upto ₹7000 annually\*



orient  
BLDC FANS

BDLC FANS

JAZZ BLDC



Metallic Bronze Copper



Ash Rose



Royal Manioca



Daytone Grey



Orbes White

COMPARISON



Stylish blade trims with metallic finish

Integrated PU painted & metallized trims for astonishing and impeccable aesthetics

50% energy savings

Stabilizer free functioning (120V – 280V)

3 Years warranty



Sweep (mm)	Air Delivery (cmm)	RPM	Power (W)
1200	215	350	33

\*On using four fans for 16 hours daily throughout one year.

save upto ₹7000 annually\*



orient BLDC FANS

BLDC FANS

WENDY BLDC



COMPARISON

 Dual colour tone with integrated trims

 50% energy savings

 3 Years warranty

 Available with Remote

 Ribbed Aluminum, extra wide blades for higher air delivery and thrust

 Stabilizer free Functioning (120V – 280V)

Sweep (mm)	Air Delivery (cmm)	RPM	Power (W)
1200	230	350	35

save upto ₹7000 annually\*



orient BLDC FANS



FEATURES

PRODUCTS

Easy Bring home a beauty that just won't quit. Orient Decorative Fans are a seamless mix of art and science with top-notch performance packed in an elegant package that takes your breath away

## Decorative Fans

DECORATIVE FANS

Orient's range of aesthetically brilliant and functionally optimized fans give our consumers the best of both worlds. These fans smoothly fit into the 'modern home' style, capturing the attention of everyone with their sheer elegance while filling every space with unmatched comfort!



Seamless in-mould design  
for elegant home decors



ANTIVIRAL  
PAINT



DECORATIVE FANS



Morace



Stallion



Quasar



Kiara Antidust



Jazz Art



Quadro Ornamental



Wendy



Areta



Quasar Ornamental



Jazz



Gratia



Gratia Class



Adonis



Falcon 400



Falcon Deco



New Breeze



Smart Saver 50



Energy Star



Summer Cool



Summer Breeze Pro



New Air Plus

DECORATIVE FANS

MORACE



Orbes White



Brown



Daytone Grey



Royal Manioca

COMPARISON

**5 YEARS WARRANTY**

**HIGH SPEED**

REVOLUTIONARY **IMD** TECHNOLOGY

Seamless in-mould design for elegant home decors

**ANTI DUST**



Antiviral Technology with bactericidal surface coating.

High Air delivery and Air throw

Wider Tip Aluminium blades for Better Air Spread

Anti-dust and easy to clean

Exotic trim design blends with modern interiors

Sweep (mm)	Air Delivery (cmm)	RPM	Power (W)
1200	215	370	52



DECORATIVE FANS

STALLION

COMPARISON



With unique four blades design  
**looks as good as it cools.**



Bold design for modern homes



Wider and unique blade design



Strong, robust motor with double ball bearing



Premium electroplated finish



Four-blades for higher delivery

Sweep (mm)	Air Delivery (cmm)	RPM	Power (W)
1320	260	330	75



DECORATIVE FANS

QUASAR

COMPARISON

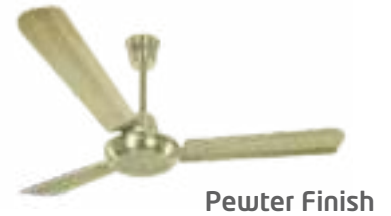

A designer fan that **packs beauty with performance.**

Sweep (mm)	Air Delivery (cmm)	RPM	Power (W)
900	140	400	38
1050	165	380	45
1200	235	320	50
1400	260	300	60



Wide blades for high air delivery



Elegant design to complement room decor



Ribbed blades & lacquer coating for durability



900mm, 1050mm and 1200mm rated BEE 2-star. 1400mm rated BEE 1-star.

DECORATIVE FANS

KIARA ANTIDUST



Azure Blue



Chocolate Gold



Pearl Metallic White



Hickory Brown

COMPARISON



Scratch resistant



Metallic finish & stylish blade trims



Attracts less dust



Full copper motor for durability



Powerful motor for high air delivery



Easy to clean

Sweep (mm)	Air Delivery (cmm)	RPM	Power (W)
1200	215	370	53



DECORATIVE FANS

JAZZ ART



Hickory Brown-Fire Waves



Pearl White Fire Waves



Topaz Gold Swing



Space Grey Crystal



Cosmos Black Blue Dot

COMPARISON



Seamless in-mould design for elegant home decors



Premium Finish with modern styling on trims



Metallic finish & stylish blade trims



Durable and strong 14 pole motor



Decorative ring on bottom cover & canopy for better aesthetics

Sweep (mm)	Air Delivery (cmm)	RPM	Power (W)
1200	215	370	53



DECORATIVE FANS

QUADRO ORNAMENTAL

COMPARISON



Metallic Ivory-Cherry



Golden Chocolate



Sea Green Oyster Green



Silver Blue

**PSP**   
Technology



Wide blades for high air delivery



Full copper motor, ribbed blades & lacquer coating for durability



Elegant design to complement room decor



Wide blades for high air delivery

Sweep (mm)	Air Delivery (cmm)	RPM	Power (W)
1200	230	320	55



DECORATIVE FANS

WENDY



Metallic Black Gold



Azure Blue Silver



Topaz Gold Brown



Pearl White Walnut

COMPARISON



Sweep (mm)	Air Delivery (cmm)	RPM	Power (W)
900	155	400	37
1200	230	320	55
1400	250	300	55



Wide blades for high air delivery



Metallic finish with lacquer coating for longer life



Full copper motor & ribbed aluminium blades for durability



Elegant looks with stylish trims

Also available in Anti Dust variant. \*Fan available with remote option in sweep size 1200mm. 900mm rated BEE 3-star. 1200mm rated BEE 2-star. 1400mm rated BEE 1-star.

DECORATIVE FANS

ARETA

COMPARISON



Pearl Metallic White



Golden Beige-Coffee



Pearl Metallic White Trendz



Matt Black Trendz



Wide blades for high air delivery



Full copper motor & ribbed aluminium blades for durability



Curvy blades & three-layered canopy



Elegant looks with decorative trims & bottom cover ring

Sweep (mm)	Air Delivery (cmm)	RPM	Power (W)
1200	230	320	53



DECORATIVE FANS

QUASAR ORNAMENTAL



Golden Chocolate



Sea Green Oyster Green



Metallic Ivory Cherry



Silver Blue

COMPARISON



Wide blades for high air delivery

Ribbed aluminium blades for durability

Lacquer coating provides longer life

Dual colour combination adds elegance to your home decor

Decorative ring on motor & canopy for better aesthetics

High air delivery

Sweep (mm)	Air Delivery (cmm)	RPM	Power (W)
600	140	850	70
900	140	400	38
1050	165	380	45
1200	235	320	50
1400	260	300	60



Also available in Anti Dust variant only in 1200mm. 900mm and 1050mm rated BEE 2-star. 1200mm rated BEE 1-star. 1400mm rated BEE 2-star.

DECORATIVE FANS

JAZZ

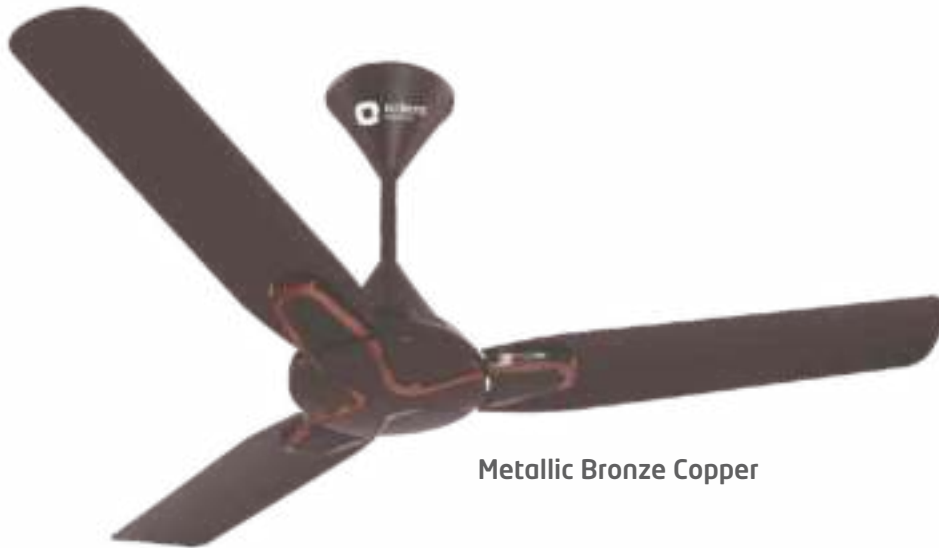

Metallic Bronze Copper

 Decorative ring on bottom cover & canopy for better aesthetics

 Durable and strong 14 pole motor

 Full copper motor & ribbed aluminium blades for durability

 Metallic finish & stylish blade trims

Sweep (mm)	Air Delivery (cmm)	RPM	Power (W)
600	110	850	68
900	155	400	37
1050	165	380	45
1200	225	380	53
1400	250	300	60

Also available in High Speed variant. 900mm rated BEE 3-star. 1050mm rated BEE 2-star, 1200mm and 1400mm rated BEE 1-star.

COMPARISON



Pearl Metallic White Chrome

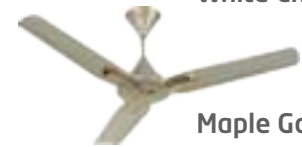

Maple Gold



Mahogany Brown



Burgandy Silver



Jazz Trendz Metallic Bronze Copper



Jazz Trendz Pearl Metallic White





DECORATIVE FANS

GRATIA



Sweep (mm)	Air Delivery (cmm)	RPM	Power (W)
600	110	850	65
900	140	400	38
1050	165	380	45
1200	220	320	53
1400	255	300	62



Also available in Anti Dust variant. Also available in High Speed variant. 900mm and 1050mm rated BEE 2-star. 1200mm and 1400mm rated BEE 1-star.

DECORATIVE FANS

GRATIA CLASS

COMPARISON



PSP Technology



Sweep (mm)	Air Delivery (cmm)	RPM	Power (W)
1200	220	320	53



Wide blades for high air delivery



Stylish bottom cover and canopy for better aesthetics



Ribbed aluminium blades for durability

DECORATIVE FANS

ADONIS



Royal Manioca



White

Brown

Daytone Grey

Metallic Bronze Copper

COMPARISON

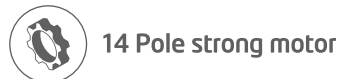

Sweep (mm)	Air Delivery (cmm)	RPM	Power (W)
1200	220	370	53



DECORATIVE FANS

FALCON 400



White



Brown



Matt Brown



Ivory



Metallic Bronze Copper

COMPARISON

**HIGH SPEED**



Full copper motor for durability



Tangential blades for better aesthetics



Rust proof aluminium blades



Strong motor (14 pole)

Sweep (mm)	Air Delivery (cmm)	RPM	Power (W)
1200	215	380	53



DECORATIVE FANS

FALCON DECO



Metallic Bronze Copper

 Fastest fan in the category (380 RPM)

 Durable motor for long life

 Ribbed aluminium blades for higher durability

 Strong motor (14 pole)

Sweep (mm)	Air Delivery (cmm)	RPM	Power (W)
1200	220	380	55



Brown

White

Daytone Grey

Royal Manioca

Aqua Teal

Ash Rose

COMPARISON



DECORATIVE FANS

NEW BREEZE

COMPARISON



Brown



White



Ivory



Strong motor for better performance



Ribbed aluminium blades for longer durability



Powder coating provides longer life



Rust proof aluminium blades

Sweep (mm)	Air Delivery (cmm)	RPM	Power (W)
900	140	400	38
1050	165	380	45
1200	225	320	44
1400	255	300	56

900mm, 1050mm and 1400mm rated BEE 2-star. 1200mm rated BEE 3-star.



DECORATIVE FANS

SMART SAVER 50

COMPARISON

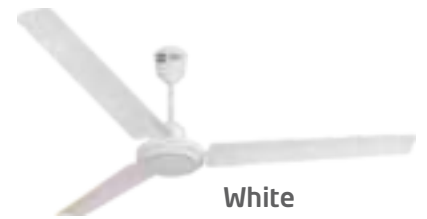

Full copper motor for durability



Powder coating provides longer life

Sweep (mm)	Air Delivery (cmm)	RPM	Power (W)
1200	220	350	50



DECORATIVE FANS

ENERGY STAR

COMPARISON



Teakwood



Pearl Ivory

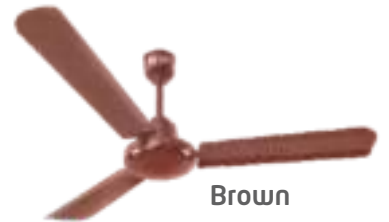

Brown



Roswood



Sweep (mm)	Air Delivery (cmm)	RPM	Power (W)
1200	220	320	48





DECORATIVE FANS

**SUMMER COOL**

COMPARISON



Brown



Ivory



White



Metallic Bronze Copper

A fan that has been trusted by over 30 Million happy consumers.

 Ribbed aluminium blades for durability

 Decorative cup on the motor cover adds elegance to the decor

 Rust proof aluminium blades

 16 pole motor for higher durability

 Powder coating provides long-lasting premium finish

Sweep (mm)	Air Delivery (cmm)	RPM	Power (W)
600	140	850	70
900	140	400	38
1050	165	380	45
1200	220	320	50
1400	255	300	56

600mm, 1050mm and 1400mm rated BEE 2-star. 1200mm rated BEE 1-star.



DECORATIVE FANS

SUMMER BREEZE PRO

COMPARISON



**HIGH  
SPEED**



Sweep (mm)	Air Delivery (cmm)	RPM	Power (W)
900	138	400	38
1200	215	370	53
1400	250	300	60



Wider tip blades for better air circulation



Superior paint finish for longer & Impeccable feel



Strongest 14 pole motor in its category for higher durability



Rust proof aluminium blades

Ø900mm rated BEE 2-star. 1200mm and 1400mm rated BEE 1-star.

DECORATIVE FANS

NEW AIR PLUS



COMPARISON



Sweep (mm)	Air Delivery (cmm)	RPM	Power (W)
600	110	800	62
900	140	400	37
1050	165	380	45
1200	225	380	53
1400	250	300	58



Strong motor for better performance



Powder coating provides longer life



Ribbed aluminium blades for longer durability



Also available in variant 600mm in 4 blades. 900mm. 1050mm and 1200mm rated BEE 2-star. 1200mm and 1400mm rated BEE 1-star.



FEATURES

PRODUCTS

“Easy on the eyes. Tough on the heat. Introducing the brand-new range of portable fans from Orient - designed to stun and impress with their revolutionary designs, next-generation technology, and elegant finish. With a complete package like this, the only thing left to do is to pick what color you like”

# Lifestyle Fans

LIFESTYLE FANS

GET MOUNTAIN COOL BREEZE IN HOT SUMMERS.



CLOUD 3

REDUCES  
TEMPERATURE  
UP TO 12°C

LIFESTYLE FANS



**CLOUDCHILL™**  
TECHNOLOGY

Orient Cloud 3 is a one-of-a-kind lifestyle cooling solution powered by the unique Cloudchill technology which helps bring down the air temperature by up to 12 degree Celsius. It has an in-built cloud chamber that converts water into cloud-like microparticles which instantly cools the air while the aerodynamically designed fan blades help spread this chilled air across the room. It is easy to move and comes with a remote control for convenient usage. And all this is packed in a beautiful body that forms a perfect product to enhance the interiors of your home.

LIFESTYLE FANS



PROTEUS



CLOUD 3



BLADELESS

LIFESTYLE FANS

Orient  
CLOUD 3

COMPARISON



**TILT MECHANISM**

Adjustable downward tilt up to 10-degrees helps direct the cooling where you want it



**EASY FILL INLET FOR WATER & ICE**

Revolutionary Cloudchill technology drops temperature up to 12 degrees. For extra chill, add some ice, for a temperature drop up to 20 degrees

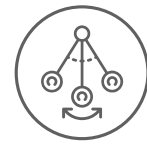

**30-DEGREE OSCILLATION**

Unique 30-degree oscillation with gliding top mechanism helps circulate cool air across the room, enhancing your comfort

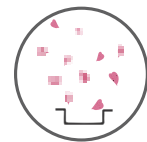

**FRAGRANCE CHAMBER**

Add fragrance of your choice in the easy fill inlet to lift your mood



Available in White and Black



**BREEZE MODE**

Experience the pleasant sensation of fresh and pure breeze inside your home with the fan's breeze mode



**ENHANCED AIR CIRCULATION WITH UNIQUE GUARD DESIGN**

Unique and elegant grill design ensures safety and helps in effective circulation of air to enhance the overall cooling experience



LIFESTYLE FANS

**Orient**  
**PROTEUS**

Voltage : 220-240V  
Frequency : 50Hz  
Power : 42W

COMPARISON



Silent operation



Strong & reliable motor



1 Hour timer



Power saving



Rotating grill

LIFESTYLE FANS

**Orient**  
**BLADELESS**  
BECAUSE DIFFERENT IS UNIQUE.

Voltage : 220-240V  
Frequency : 50/60Hz  
Power : 40W

COMPARISON



Silent operation



Strong & reliable motor



Built-in timer



Remote



Power saving



Swing



Breeze modes



Easy clean



PRODUCTS

Enjoy all-year-round cooling with our wide range of table, wall, and pedestal fans - designed with a touch of comfort and the convenience of Ergonomics.

## Table, Pedestal and Wall Fans

TPW FANS



Table Fan



Pedestal Fan

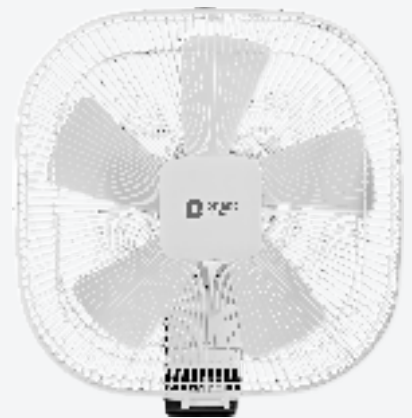

Wall Fan

TPW FANS

# WIND-PRO

COMPARISON



Desk 60

Motor with revolutionary

**CT TECH**

for smoother, longer and reliable operations.



Thermal overload protection device



Extra-high air thrust with heavenly silence motor



Elegant aesthetic with 5-leaf blades



Oscillation & speed control

Available in two colors: Snow White & Signal White

Sweep (mm)	Air Delivery (cmm)	RPM
400	100	1350

# RETRO RELIC

COMPARISON

PAGE78



Antique Brass



Antique Copper



Pewter Finish

**HIGH SPEED**

Sweep (mm)	Air Delivery (cmm)	RPM
300	47	2100



90-degree oscillation



3-Speed rotary switch control



Motor protection with thermal overload protection device & auto reset



Easy fan head tilt mechanism



High speed motor to deliver air at 2100 RPM

TPW FANS

RETRO SERIES

COMPARISON

HIGH SPEED



T12  
Rubbed Bronze



T16HS  
Rubbed Bronze



T16  
Rubbed Bronze

Motor with revolutionary



for smoother, longer and reliable operations.

Sweep (mm)	Air Delivery (cmm)	RPM
300	47	2100
400	85	2100
400	80	1300



90-degree oscillation



High speed motor gives high air thrust at 2100 RPM



Rubbed-bronze finish adds to the overall aesthetics



Motor protection through thermal overload protection device



3-Speed rotary switch control



Spiral guard design ensure international safety standard



Up & down tilt mechanism



3-speed rotary switch control



Rubbed-bronze finish adds to the overall aesthetics

TPW FANS

DESK 25

COMPARISON



Azure Blue-White



Signal White

Motor with revolutionary



for smoother, longer and reliable operations.

Sweep (mm)	Air Delivery (cmm)	RPM
400	90	1330

 Up & down tilt mechanism

 Easy snap-fit assembly

 Motor protection with thermal overload protection and auto-resetting

 3-Speed piano switch control

 Aerodynamically designed resin blades for maximum air delivery

 Extra protection against corrosion with powder-coated guard and polymer ring

 90-degree oscillation



TPW FANS

DESK 26

COMPARISON



Azure Blue-white



Crimson Red-white



Crystal White

Motor with revolutionary



for smoother, longer and reliable operations.

Sweep (mm)	Air Delivery (cmm)	RPM
400	90	1330

 Up & down tilt mechanism

 Easy snap-fit assembly

 Aerodynamically designed resin blades for maximum air delivery

 3-Speed piano switch control

 Motor protection with thermal overload protection and auto-resetting

 Extra protection against corrosion with powder-coated guard and polymer ring

 90-degree oscillation

# DESK 71

COMPARISON



Desk 71

Motor with revolutionary



for smoother, longer and reliable operations.

Sweep (mm)	Air Delivery (cmm)	RPM
400	90	1330

 Up & down tilt mechanism

 90-degree oscillation

 3-Speed rotary switch control

 Extra protection against corrosion with powder-coated guard and polymer ring

 Motor protection with thermal overload protection

 Aerodynamically designed resin blades for maximum air delivery

# DESK 26

## Trendz

COMPARISON



Electric Blue

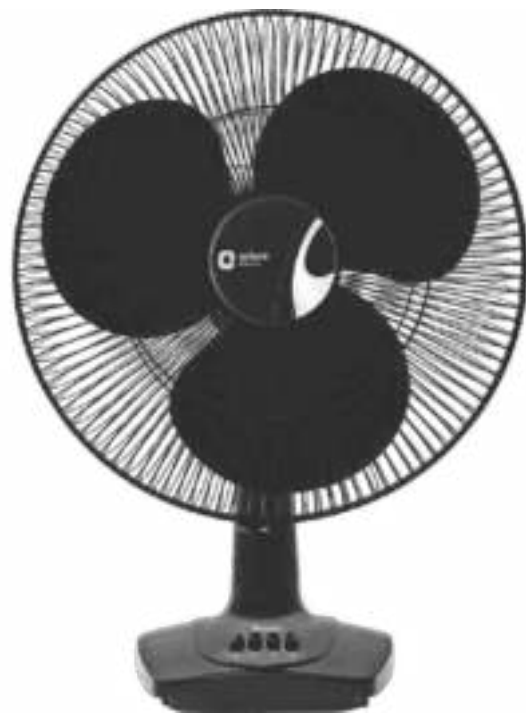

Slate Grey

Motor with revolutionary



for smoother, longer and reliable operations.

Sweep (mm)	Air Delivery (cmm)	RPM
400	90	1330

 Up & down tilt mechanism

 3-speed piano switch control

 Aerodynamically designed resin blades ensure high thrust of air

 90-degree oscillation

 Motor protection with thermal overload protection and auto-resetting

 Extra protection against corrosion with powder-coated guard and polymer ring

 Easy snap-fit assembly

# TABLE 27

## Trendz

COMPARISON



Slate Grey



Electric Blue

**HIGH  
SPEED**

Sweep (mm)	Air Delivery (cmm)	RPM
400	100	2100

 Up & down tilt mechanism

 Motor protection with thermal overload protection and auto-resetting

 3-speed piano switch control

 Aerodynamically designed resin blades for high air delivery

 Extra protection against corrosion with powder-coated guard and polymer ring

TPW FANS

# FINSTAR DESK-21

COMPARISON



Crystal White



Crimson Red - White



Azure Blue - White



Up & down tilt mechanism



3-speed piano switch control



90-degree oscillation



Strong and reliable motor with thermal overload protection device

Sweep (mm)	Air Delivery (cmm)	RPM
400	85	1330

TPW FANS

TABLE 27

COMPARISON



Commander Grey



Signal White



Up & down tilt mechanism



2100 RPM For high air thrust



Aerodynamically designed resin blades for maximum air delivery



3-speed piano switch control



Motor protection with thermal overload protection and auto resetting



Extra protection against corrosion with powder-coated guard and polymer ring

Sweep (mm)	Air Delivery (cmm)	RPM
400	100	2100

# DESK 17

COMPARISON



Crystal White

**HIGH  
SPEED**

Sweep (mm)	Air Delivery (cmm)	RPM
300	80	2100

 3-Speed rotary Switch control

 Up & down index tilt mechanism

 Extra protection against corrosion with powder-coated guard and polymer ring

 90-degree oscillation

 Ideal for small cabins, offices & homes

 Aerodynamically designed resin blades for maximum air delivery

 2100 RPM For high air thrust

 Motor protection with thermal overload protection and auto-resetting

TPW FANS

# ZIPPY

COMPARISON



Blue-White

**HIGH SPEED**



Aerodynamic plastic blades for high air thrust



Attractive colour combination



2-in-1 advantage of wall mounting & table-top usage



Motor protected through thermal overload protection device



Heavy-duty motor with 2500 RPM provides high air thrust

Sweep (mm)	Air Delivery (cmm)	RPM
225	16	2500



TPW FANS

# TORNADO-II

COMPARISON



Gunmetal



Chorme



Black

For Commercial Use

**ALL METAL  
CONSTRUCTION**

Sweep (mm)	Air Delivery (cmm)	RPM
450	110	1325



Powerful motor for high air delivery



Unique oil reservoir lubrication for better reliability & longer life



Unique oscillation mechanism



Unit packing with easy assembly



Extra protection against corrosion with powder-coated guard and polymer ring



3-speed regulation & On Off control



Thermal overload protection with auto-reset



Aerodynamic metal blades for high air thrust

# FARATA FT-01

COMPARISON



Black

## For Commercial Use



Balanced operation & powder-coated finish ensure longer life



3-speed rotary Switch control



Heavy-duty motor & aerodynamic blades give high air thrust at minimum noise

Sweep (mm)	Air Delivery (cmm)	RPM
500	167	1400

TPW FANS

STAND 37

COMPARISON



Signal White



Crystal White

**HIGH  
SPEED**

Sweep (mm)	Air Delivery (cmm)	RPM
400	100	2100

 Up & down tilt mechanism

 90-degree oscillation

 Aerodynamically designed resin blades for high air delivery

 2100 RPM with high speed powerful motor

 Motor protection with thermal overload protection and auto-resetting

 Extra protection against corrosion with powder-coated guard and polymer ring

TPW FANS

STAND 37  
*Trendz*

COMPARISON



Slate Grey

**HIGH  
SPEED**

Sweep (mm)	Air Delivery (cmm)	RPM
400	100	2100



Up & down tilt mechanism



3-Speed piano switch control



Telescopic arrangement for full height adjustment by contemporary collet



90-degree oscillation



High speed motor gives high air thrust at 2100 RPM

TPW FANS

# STAND 33



Signal White



Off White

COMPARISON

Motor with revolutionary



for smoother, longer and reliable operations.

Sweep (mm)	Air Delivery (cmm)	RPM
400	90	1330

 Up & down tilt mechanism

 Specially designed high torque motor

 Motor protection with thermal overload protection device

 90-degree oscillation

 Aerodynamically designed resin blades ensure high thrust of air

 Extra protection against corrosion with powder-coated guard and polymer ring

 3-speed piano switch control

TPW FANS

# STAND 31

COMPARISON



Crison Red



Crystal White



Signal White

Motor with revolutionary



for smoother, longer and reliable operations.

Sweep (mm)	Air Delivery (cmm)	RPM
400	90	1330

 Up & down tilt mechanism

 Cross-steel base adds elegance to the decor

 Motor protection with thermal overload protection device

 3-speed piano switch control

 Aerodynamically designed resin blades for high air delivery

 90-degree oscillation

 Extra protection against corrosion with powder-coated guard and polymer ring

TPW FANS

# STAND 35

COMPARISON



Rubbed Bronze

Motor with revolutionary



for smoother, longer and reliable operations.



Sleek 4-leaf aluminium blade classic design



Specially designed high torque motor



Attractive rubbed-bronze finish



Extra protection against corrosion with powder-coated guard and metal ring

Sweep (mm)	Air Delivery (cmm)	RPM
400	80	1300

TPW FANS

# STAND 35HS

COMPARISON



Rubbed Bronze

Motor with revolutionary



for smoother, longer and reliable operations.



 Sleek 4-leaf aluminium blade classic design

 Attractive rubbed-bronze finish

 Specially designed high torque motor

 Extra protection against corrosion with powder-coated guard and metal ring

Sweep (mm)	Air Delivery (cmm)	RPM
400	90	1330



TPW FANS

STAND 32  
*Trendz*



Electric Blue

COMPARISON

Motor with revolutionary



for smoother, longer and reliable operations.

Sweep (mm)	Air Delivery (cmm)	RPM
400	90	1330



Extra protection against corrosion with powder-coated guard and polymer ring



Motor protection thermal overload protection device with auto-reset



Aerodynamically designed resin blades for high air delivery

TPW FANS

# STAND 38

COMPARISON



Crystal White

Motor with revolutionary



for smoother, longer and reliable operations.

Sweep (mm)	Air Delivery (cmm)	RPM
450	92	1330

 Up & down tilt mechanism

 Extra protection against corrosion with powder-coated guard and polymer ring

 Motor protection with thermal overload protection device

 90-degree oscillation

 Aerodynamically designed resin blades give high air thrust

 Front & back guard with extra ribs for safety

 Specially designed high torque motor

 Sleek switch panel & round base add elegance to the decor

TPW FANS

# STAND 32

COMPARISON



Grey



Crimson Red-white



Signal White

Motor with revolutionary



for smoother, longer and reliable operations.

Sweep (mm)	Air Delivery (cmm)	RPM
400	90	1330

 Up & down tilt mechanism

 Telescopic arrangement for full height adjustment by contemporary collet

 Aerodynamically designed resin blades for high air delivery

 90-degree oscillation

 Square base finish adds to the overall aesthetics

 Extra protection against corrosion with powder-coated guard and polymer ring

 3-speed piano switch control

 Motor protection with thermal overload protection device

TPW FANS

# FINSTAR STAND

COMPARISON



Crystal White



Azure Blue White



Crimson Red White

Motor with revolutionary



for smoother, longer and reliable operations.

Sweep (mm)	Air Delivery (cmm)	RPM
400	85	1330



Up & down tilt mechanism



Strong and reliable motor with thermal overload protection device



90-degree oscillation



Telescopic arrangement for full height adjustment



Extra protection against corrosion with powder-coated guard and polymer ring

TPW FANS

# STYLUS

COMPARISON



Motor with revolutionary

**CT TECH**

for smoother, longer and reliable operations.

Sweep (mm)	Air Delivery (cmm)	RPM
400	100	1350

 Manual and remote control

 Breeze mode and timer for auto switch off

 High air delivery at moderate power consumption

 Unique square guard with radial wires

 Unique combination of motor and blade for more air thrust

 Thermal overload protection device

 Super-efficient and silent motor

 90-degree oscillation with remote control

TPW FANS

# WIND-PRO

COMPARISON



Stand 70

Motor with revolutionary



for smoother, longer and reliable operations.

Sweep (mm)	Air Delivery (cmm)	RPM
400	100	1350

Available in two colors: Snow White & Signal White



Thermal overload protection device



Extra-high air thrust with heavenly silence motor



Elegant aesthetic with 5-leaf blades



Oscillation & speed control

TPW FANS

# STYLUS

COMPARISON

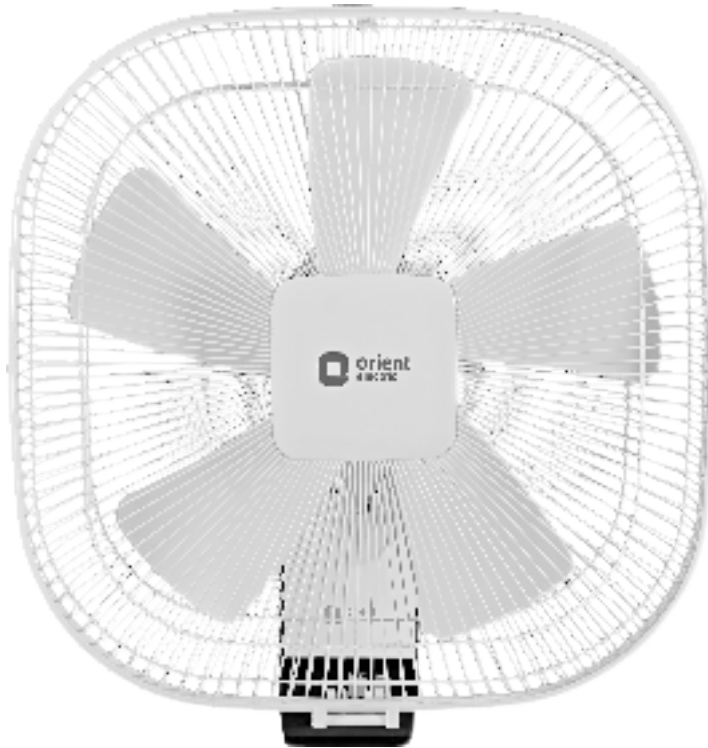

Stylus Wall

Motor with revolutionary



for smoother, longer and reliable operations.

Sweep (mm)	Air Delivery (cmm)	RPM
400	100	1350

 Manual and remote control

 Breeze mode and timer for auto switch off

 High air delivery at moderate power consumption

 Unique square guard with radial wires

 Unique combination of motor and blade for more air thrust

 Thermal overload protection device

 Super-efficient and silent motor

 90-degree oscillation with remote control

# WIND-PRO

COMPARISON



Wall 80

Motor with revolutionary



for smoother, longer and reliable operations.

Sweep (mm)	Air Delivery (cmm)	RPM
400	100	1350

Available in two colors: Snow White & Signal White



Thermal overload protection device



Elegant aesthetic with 5-leaf blades



Extra-high air thrust with heavenly silence motor



Oscillation & speed control



TPW FANS

WALL 49

COMPARISON



Crystal White



Available with Remote

Motor with revolutionary



for smoother, longer and reliable operations.

Sweep (mm)	Air Delivery (cmm)	RPM
400	90	1330

 Up & down tilt mechanism

 Extra protection with powder-coated guard and polymer ring

 Automatic speed control through the breeze control button

 Aerodynamic blades for high air thrust

 Motor protection with thermal overload protection device

 Advanced touch-screen panel for manual operation

TPW FANS

# WALL 41

COMPARISON





Crystal White

Motor with revolutionary





for smoother, longer and reliable operations.

Sweep (mm)	Air Delivery (cmm)	RPM
400	90	1330

-  90-degree oscillation
-  Up & down tilt mechanism
-  3-Speed piano switch control

-  Powerful motor for high air delivery
-  Aerodynamic resin blades for high air thrust
-  Front & back guard with extra ribs for safety

-  Extra protection with powder-coated guard and polymer ring
-  Motor protected with thermal overload protection device

TPW FANS

# WALL 44

COMPARISON



Crystal White



Azure Blue-white



Crimson Red-white

Motor with revolutionary



for smoother, longer and reliable operations.

Sweep (mm)	Air Delivery (cmm)	RPM
400	90	1330

Up & down tilt mechanism

Aerodynamic resin blades for high air thrust

90-degree oscillation

Extra protection against corrosion with powder-coated guard and polymer ring

Powerful motor for high air delivery

Motor protected with thermal overload protection device

TPW FANS

# FINSTAR WALL

WITH PULL CHORD MECHANISM

COMPARISON



Crimson Red White



Crystal White

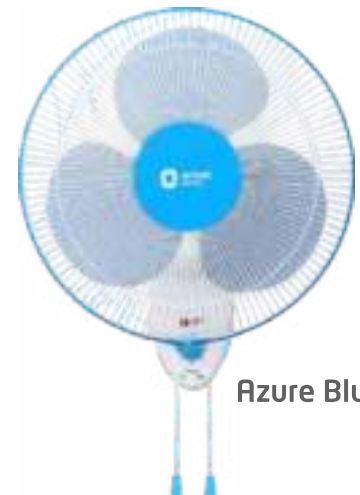

Azure Blue White

Motor with revolutionary

**CT TECH**

for smoother, longer and reliable operations.

Sweep (mm)	Air Delivery (cmm)	RPM
400	85	1330



Up & down tilt mechanism



Strong and reliable motor with thermal overload protection device



90-degree oscillation



Extra protection against corrosion with powder-coated guard and polymer ring

TPW FANS

# FINSTAR WALL

WITH PULL CHORD MECHANISM

COMPARISON



Crystal White

**HIGH  
SPEED**

Sweep (mm)	Air Delivery (cmm)	RPM
300	80	2100

 Up & down tilt mechanism

 Motor protection with thermal overload protection and auto-resetting

 Aerodynamically designed resin blades for maximum air delivery

 3-Speed rotary switch control

 Specially designed motor gives high air thrust 2100 RPM

 Extra protection against corrosion with powder-coated guard and polymer ring

TPW FANS

WALL 47

COMPARISON



Crystal White



Signal White

**HIGH  
SPEED**

Sweep (mm)	Air Delivery (cmm)	RPM
400	100	2100

 Up & down tilt mechanism

 Motor protection with thermal overload protection and auto-resetting

 Aerodynamically designed resin blades for maximum air delivery

 3-Speed rotary switch control

 Specially designed motor gives high air thrust 2100 RPM

 Extra protection against corrosion with powder-coated guard and polymer ring

# WALL 11

COMPARISON



Wall 11

Motor with revolutionary

**CT TECH**

for smoother, longer and reliable operations.

Sweep (mm)	Air Delivery (cmm)	RPM
300	50	1400

 Up & down tilt mechanism

 Powerful motor for high air delivery

 Aerodynamic resin blades for high air thrust

 90-degree oscillation

 Oscillation & speed control by pull-cord mechanism

 Motor protection with thermal overload protection

TPW FANS

# WALL 43

COMPARISON



Wall 43

Motor with revolutionary

**CT TECH**

for smoother, longer and reliable operations.

Sweep (mm)	Air Delivery (cmm)	RPM
400	90	1330

 Up & down tilt mechanism

 Powerful motor for high air delivery

 Aerodynamic resin blades for high air thrust

 3-Speed rotary switch control

 Oscillation & speed control by pull-cord mechanism

 Motor protection with thermal overload protection

 90-degree oscillation

 Extra protection with powder-coated guard and polymer ring



TPW FANS

# ROTO-53

COMPARISON



Crystal White

Motor with revolutionary



for smoother, longer and reliable operations.



Wall mounting regulator



360-degree cyclic motion



Powerful motor for high air delivery



Extra protection against corrosion with powder-coated guard and polymer ring

Sweep (mm)	Air Delivery (cmm)	RPM
400	90	1330

# WALL 44

## Trendz

COMPARISON



Slate Grey



Electric Blue

Motor with revolutionary



for smoother, longer and reliable operations.

Sweep (mm)	Air Delivery (cmm)	RPM
400	90	1330

 Up & down tilt mechanism

 Powerful motor for high air delivery

 Motor protection with thermal overload protection device

 90-degree oscillation

 Aerodynamic Resin Blades For high air thrust

 Extra protection with powder-coated guard and polymer ring

 3-speed piano switch control

TPW FANS

**WALL 47**  
*Trendz*

COMPARISON



Slate Grey



Electric Blue

**HIGH  
SPEED**

Sweep (mm)	Air Delivery (cmm)	RPM
400	100	2100



Up & down tilt mechanism



Specially designed motor gives high air thrust 2100 RPM



Oscillation & speed control by pull cord mechanism



90-degree oscillation



Extra protection with powder-coated guard and polymer ring



Aerodynamic Resin Blades For high air thrust



Motor protection with thermal overload protection device



Keep cool, Keep calm. Stay noise-free! Orient's next-generation of exhaust fans deliver cleaner air, dust-free surroundings, and top-notch performance in an elegant design that complements your décor and lifts the mood!

# Exhaust Fans

EXHAUST FANS



Smart Air Neo SF



Ventilator HS

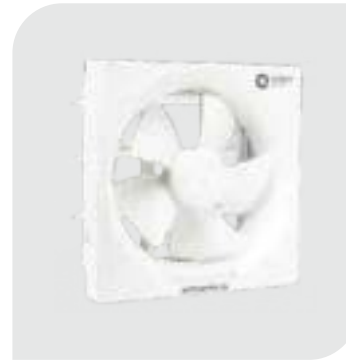

Ventilator DX



Smart Air LSH



Smart Air Neo

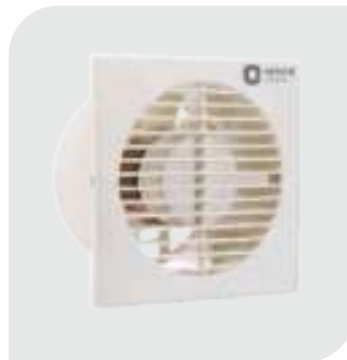

Smart Air

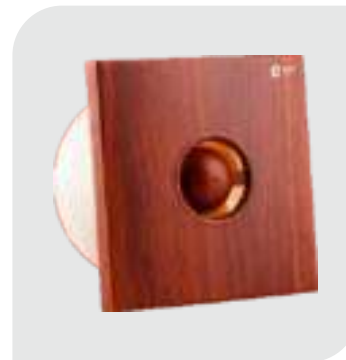

Venito Air



High Speed Exhaust



Hill Air



Air flow



Spring Air



Power Flow

EXHAUST FANS

# SMART AIR NEO SF

COMPARISON



Silver Finish

**HIGH  
SPEED**



Strong powerful motor



Glass Mountable



Easy to clean



Powerful air suction



Ideal for kitchens & bathrooms

Sweep (mm)	Air Delivery (cmm)	RPM
150	250	2000

EXHAUST FANS

# VENTILATOR HS

COMPARISON



**HIGH SPEED**



Smooth & silent operation



Dust protection shutter



Sleek & trendy design



2 years warranty

Sweep (mm)	Air Delivery (cmm)	RPM
150	500	2500
200	750	2100

EXHAUST FANS

# VENTILATOR DX

COMPARISON



Resin body & blades for easy maintenance



Shutter to prevent dust from outside



International design



2 years warranty

Sweep (mm)	Air Delivery (cmm)	RPM
150	280	1350
200	550	1300
250	780	1270



EXHAUST FANS

# SMART AIR LSH

COMPARISON



Off White

**HIGH SPEED**



Strong powerful motor



Glass Mountable



Easy to clean



Powerful air suction



Ideal for kitchens & bathrooms

Sweep (mm)	Air Delivery (cmm)	RPM
150	230	2000

EXHAUST FANS

# SMART AIR NEO

COMPARISON



Off White

**HIGH SPEED**



Strong powerful motor



Glass Mountable



Easy to clean



Powerful air suction



Ideal for kitchens & bathrooms

Sweep (mm)	Air Delivery (cmm)	RPM
100	90	2500
150	250	2000

EXHAUST FANS

SMART AIR

COMPARISON



Stylish, compact fan with super efficient motor



Sturdy front grill for additional safety

Sweep (mm)	Air Delivery (cmm)	RPM
100	90	2400
150	240	1800

EXHAUST FANS

VENITO AIR

COMPARISON



Wooden Finish

Off White



Strong powerful motor



Glass Mountable



Easy to clean



Powerful air suction



Ideal for kitchens & bathrooms



Elegant design

Sweep (mm)	Air Delivery (cmm)	RPM
150	280	2000

EXHAUST FANS

# HIGH SPEED EXHAUST

COMPARISON



Front guard protection for bird



Powerful air suction



Ideal for kitchens & bathrooms



Powder-coated for long life

Sweep (mm)	Air Delivery (cmm)	RPM
230	1150	2250

EXHAUST FANS

# HILL AIR

COMPARISON



Front guard protection  
for bird



Powder-coated  
for long life



Ideal for kitchens  
& bathrooms

Sweep (mm)	Air Delivery (cmm)	RPM
230	550	1350
300	1290	1300

EXHAUST FANS

# AIR FLOW

COMPARISON



Powder-coated  
for long life



Resin blades for  
easy cleaning

Sweep (mm)	Air Delivery (cmm)	RPM
150	400	2600
230	550	1350
300	1290	1300

EXHAUST FANS

# SPRING AIR

COMPARISON



Powder-coated  
for long life



Resin blades for  
easy cleaning

Sweep (mm)	Air Delivery (cmm)	RPM
230	650	1300
300	1290	1300



EXHAUST FANS

# POWER FLOW

COMPARISON



Powerful air suction



Powder-coated for long life



Ideal for low end industrial use

Sweep (mm)	Air Delivery (cmm)	RPM
150	500	2600

EXHAUST FANS

# POWER FLOW

COMPARISON



Powerful air suction



Powder-coated for long life



Ideal for low end industrial use



Double ball-bearing

Sweep (mm)	Air Delivery (cmm)	RPM
230	865	1350
300	1800	1320



Works like a charm. Heavy duty fans for Industrial use.

# Industrial Fans

INDUSTRIAL FANS



Thunderstorm Wall Fan



Thunderstorm Stand Fan



Heavy-Duty Exhaust



Air Circulator Wall 18/24



Air Circulator Stand 18/24

INDUSTRIAL FANS

# THUNDERSTORM WALL FAN

COMPARISON



Sweep Model	Sweep (mm)	Sweep (RPM)	Phase	Power Input (Watt)	Current (AMP)	Air Delivery (CMH)	Noise Level (DB)
450 mm AC(Wall)	450	1450 5%	1	80 10%	0.34	9000	60 65

Sweep Model	Sweep (mm)	Sweep (RPM)	Phase	Power Input (Watt)	Current (AMP)	Air Delivery (CMH)	Noise Level (DB)
600 mm (24" Wall)	600	1450 5%	1	170 10%	0.34	18000	70 75

-  Double ball bearings ZZ (Permanent lubricated) for longer life
-  Powerful air circulator motor for continuous operation with high air delivery & thrust
-  It comes with the air direction control by telescopic height adjustment
-  Motor protection thermal overload protection device with auto-reset
-  Narrow aerodynamically designed blades for providing Low Noise
-  Sturdy metallic body for durability
-  Tilt adjustment for adjusting the fan till 15% angle
-  Floating arrangement for changing the position of oscillation

INDUSTRIAL FANS

# THUNDERSTORM STAND FAN

COMPARISON



Sweep Model	Sweep (mm)	Sweep (RPM)	Phase	Power Input (Watt)	Current (AMP)	Air Delivery (CMH)	Noise Level (DB)
450 mm AC(Stand)	450	1450 5%	1	80 10%	0.34	9000	60 65

Sweep Model	Sweep (mm)	Sweep (RPM)	Phase	Power Input (Watt)	Current (AMP)	Air Delivery (CMH)	Noise Level (DB)
600 mm (24" Stand)	600	1450 5%	1	170 10%	0.34	18000	70 75



Double ball bearings ZZ (Permanent lubricated) for longer life



Motor protection thermal overload protection device with auto-reset



It comes with the air direction control by telescopic height adjustment



Powerful air circulator motor for continuous operation with high air delivery & thrust



Narrow aerodynamically designed blades for providing "Low Noise"



Sturdy metallic body for "durability"



Tilt adjustment for adjusting the fan till 15° angle



Floating arrangement for changing the position of oscillation

INDUSTRIAL FANS

HEAVY DUTY EXHAUST

COMPARISON

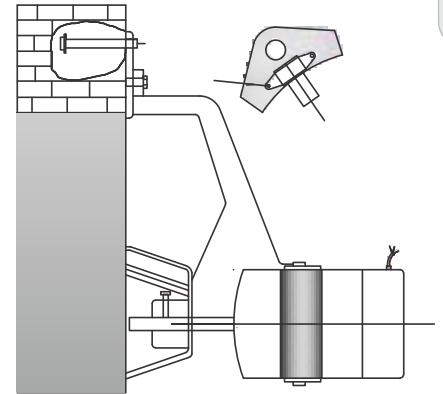
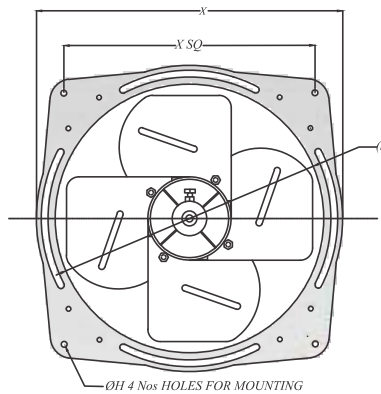

IP55 Protected



Sweep (mm)	Phase	Speed (RPM)	Power (watt)	Current (AMP)	Air Delivery (CMH)	Noise label (DBA)
300	Single	900	55	0.24	1145	45
		1400	85	0.41	1710	50
380	Single	900	105	0.45	2000	55
		1400	155	0.70	3250	60
450	Single	900	150	0.67	3900	60
		1400	330	1.5	6120	70
600	Single	700	255	1.15	7100	65
		900	485	2.1	9400	70
380	Three	1400	155	0.3	3250	60
450	Three	1400	355	0.6	6120	70
600	Three	900	485	0.9	9400	70

S. No.	Product	ØX	ØH	ØS	Y SQ
1.	Heavy-duty Exhaust Fan	384	7.8	320	313
2.	Heavy-duty Exhaust Fan	468	10.8	405	373
3.	Heavy-duty Exhaust Fan	548	10.8	484	447
4.	Heavy-duty Exhaust Fan	718	10.8	632	603



Pre-lubricated double ball bearing for maintenance free running



Aerodynamically contoured blades to handle maximum air delivery with minimum power consumption



Motor protected with thermal overload protection device



Class 'B' insulation



Epoxy powder coating to resist corrosion



Powerful air suction

INDUSTRIAL FANS

WALL AC 18



IP55 Protected

STAND AC-18



COMPARISON



High torque gear box with safety clutch



Best-in-category air thrust



3-speed control



Broad blade profile for low noise



Up & down tilt mechanism



Motor protection thermal overload protection device with auto-reset



90-degree oscillation



Spiral guard design ensure international safety standard



Powerful air circulator motor for high air delivery & thrust

Sweep Model	Sweep (mm)	Sweep (RPM)	Phase	Power Input (Watt)	Current (AMP)	Air Delivery (CMH)	Noise Level (DB)
450 mm AC (Stand Wall)	450	1450 5%	1	100 10%	0.43	8100	50 60

Tolerance on ratings (As per IS 2997-1964) Speed -10% Power 10% Air Delivery -10%



INDUSTRIAL FANS

WALL AC-24



IP55 Protected

STAND AC-24



COMPARISON



High torque gear box with safety clutch



Best-in-category air thrust



Indexed floating system in the motor head



Up & down tilt mechanism



Motor protection thermal overload protection device with auto-reset



90-degree oscillation



Spiral guard design ensure international safety standard



Powerful air circulator motor for high air delivery & thrust



Environment protection with durable powder coating

Sweep Model	Sweep (mm)	Sweep (RPM)	Phase	Power Input (Watt)	Current (AMP)	Air Delivery (CMH)	Noise Level (DB)
600mm 24" (Stand Wall)	600	1450 5%	1	200 10%	0.85	15000	60 65

Tolerance on ratings (As per IS 2997-1964) Speed -10% Power 10% Air Delivery -10%

## PRODUCT COMPARISON

Model	SWEEP Size (MM)	SPEED (RPM)	AIR DELIVERY (CMM)	Power Consumption (Watts)	BEE Star Rating	USP
I-Float	1200	330	215	32	*****	BLDC
Hector 500	1400	300	260	35	*****	BLDC
I-Tome (With Remote)	1200	370	220	26	*****	BLDC
I-Tome	1200	370	220	28	*****	BLDC
Hector 500 With Remote	1200	350	230	28	*****	BLDC
Hector 500	900	450	140	25	*****	BLDC
I-Tome	1400	300	250	35	*****	BLDC
I Float IOT	1200	330	215	32	*****	BLDC
Ecotech Pro Re (RF)	1200	370	220	26	*****	BLDC
Ecotech Pro	1200	370	220	32	*****	BLDC
Ujala Pro	1200	370	220	32	*****	BLDC
Hector 500	1200	350	230	32	*****	BLDC
I Tome Plus	1200	370	220	26	*****	BLDC
I Falcon Deco	1200	350	225	30	*****	BLDC
Ecotech Supreme	1200	370	220	30	*****	BLDC
I Tome Smart	1200	370	220	28	*****	BLDC
I Falcon	1200	350	225	30	*****	BLDC
Apex ES	1200	370	225	30	*****	BLDC
Jazz BLDC	1200	350	215	33	*****	BLDC
Wendy BLDC	1200	350	230	35	*****	BLDC
Ecotech Supreme Re	1200	370	220	30	*****	BLDC
Hector Deco	1200	350	230	30	*****	BLDC
Ecotech Pro Remote (IR)	1200	370	220	32	*****	BLDC
Ecotech Prime	1200	350	220	32	*****	BLDC
Aeroquiet BLDC	1230	310	240	35	*****	BLDC
Gratia Antidust	1200	320	220	55	*	Anti-Dust
Gratia Antidust HS	1200	370	215	53	*	Anti-Dust
Gratia Shine Hi Speed	1200	370	215	53	*	Anti-Dust
Kiara Antidust	1200	370	215	53	*	Anti-Dust
Laurel Antidust	1200	370	220	53	*	Anti-Dust
Quasar Ornamental Antidust	1200	320	235	50	**	Anti-Dust
Wendy Antidust	1200	320	230	55	*	Anti-Dust
Morace	1200	370	215	52	*	Induction
Wendy	900	400	155	37	***	Induction
Wendy	1200	320	230	55	*	Induction
Quasar	1200	320	235	50	**	Induction
Quasar	1400	300	260	60	*	Induction
Quasar	900	400	140	38	**	Induction
Quasar	1050	380	165	45	**	Induction
Quasar Ornamental	1200	320	235	50	**	Induction
Quasar Ornamental	1400	300	260	60	*	Induction
Quasar Ornamental	900	400	140	38	**	Induction
Quasar Ornamental	1050	380	165	45	**	Induction
Summer Pride	1200	320	220	50	*	Induction
Wendy	1400	300	250	55	**	Induction
Summer Chill	1200	370	215	53	*	Induction

## PRODUCT COMPARISON

Model	SWEEP Size (MM)	SPEED (RPM)	AIR DELIVERY (CMM)	Power Consumption (Watts)	BEE Star Rating	USP
Adena Prime	1200	320	220	55	*	Induction
Adonis	1200	370	220	53	*	Induction
Aeroquiet Baby	900	430	150	48	*	Induction
Areta	1200	320	230	53	*	Induction
Areta Trendz	1200	320	230	53	*	Induction
Avalon Prime	1200	320	220	55	*	Induction
Dior	1200	370	215	53	*	Induction
Energy Star	1200	320	220	48	*	Induction
Falcon 400	1200	380	215	53	*	Induction
Falcon Deco	1200	380	220	55	*	Induction
Fantoosh	1200	320	215	53	*	Induction
Gratia	900	400	140	38	**	Induction
Gratia	1050	380	165	45	**	Induction
Gratia	1200	320	220	53	*	Induction
Gratia	1400	300	255	62	*	Induction
Gratia Class	1200	320	220	53	*	Induction
Gratia Hi Speed	1200	370	215	53	*	Induction
Gratia Hi Speed	1200	380	225	50	**	Induction
IS 50	1200	350	220	50	*	Induction
Jazz	1050	380	165	45	**	Induction
Jazz	900	400	155	37	***	Induction
Jazz	1400	300	250	60	*	Induction
Jazz	1200	380	225	53	*	Induction
Jazz Art	1200	370	215	53	*	Induction
Jazz Trendz	1200	370	215	53	*	Induction
Laurel	1200	370	220	53	*	Induction
New Air Plus	1050	380	165	45	**	Induction
New Air Plus	1400	300	250	58	*	Induction
New Air Plus	900	400	140	37	**	Induction
New Air Plus	1200	380	225	53	*	Induction
New Breeze	1050	380	165	45	**	Induction
New Hurricane	1050	380	165	45	**	Induction
New Hurricane	1400	300	250	58	*	Induction
New Hurricane	900	400	140	37	**	Induction
New Hurricane	1200	370	215	53	*	Induction
New Breeze	900	400	140	38	**	Induction
New Breeze	1400	300	255	56	**	Induction
New Breeze 3S	1200	320	225	44	***	Induction
Norton	1200	370	215	53	*	Induction
Orient-G	1400	300	255	55	**	Induction
Orient Joan	1200	320	220	50	*	Induction
Orient-G	1200	320	215	50	*	Induction
Orina	1200	320	230	55	*	Induction
Quadro Ornamental	1200	320	230	55	*	Induction
Smart Saver 50	1200	350	220	50	*	Induction
Summer Breeze	1200	370	220	50	*	Induction

## PRODUCT COMPARISON

Model	SWEEP Size (MM)	SPEED (RPM)	AIR DELIVERY (CMM)	Power Consumption (Watts)	BEE Star Rating	USP
Summer Breeze	900	400	150	38	**	Induction
Summer Breeze	1400	300	250	55	**	Induction
Summer Breeze Pro	1200	370	215	53	*	Induction
Summer Breeze Pro	1400	300	250	60	*	Induction
Summer Breeze Pro	900	400	138	38	**	Induction
Summer Chill	900	400	140	37	**	Induction
Summer Cool	1200	320	220	50	*	Induction
Summer Crown	1200	320	220	48	*	Induction
Summer Delite Decore	1400	300	255	55	**	Induction
Summer Delite Ornamental	1200	320	220	50	*	Induction
Summer Delite Ornamental	1400	300	255	55	**	Induction
Summer Delite Ornamental	1050	380	165	45	**	Induction
Summer King	1050	380	165	45	**	Induction
Summer King XI	1200	320	220	50	*	Induction
Summer Pride	1400	300	245	55	*	Induction
Summercool	900	400	140	38	**	Induction
Summer Cool	1400	300	255	56	**	Induction
Summer cool	1050	380	165	45	**	Induction
Tuister Hi-Speed	1200	370	220	50	*	Induction

Retro Series				
Model	SWEEP Size (MM)	SPEED (RPM)	AIR DELIVERY (CMM)	Power Consumption (Watts)
Retro Relic	400	2100	47	60
Retro T12	400	2100	47	60
Retro T16	400	1300	80	56
Stand 35	400	1300	80	56
Retro T16 HS	400	2100	85	90
Stand 35 HS	400	2100	85	90

Trendz Series				
Model	SWEEP Size (MM)	SPEED (RPM)	AIR DELIVERY (CMM)	Power Consumption (Watts)
Desk 26 Trendz	400	1330	84	58
Stand 32 Trendz	400	1330	84	58
Wall 44 Trendz	400	1330	84	58
Table 27 Trendz	400	2100	100	110
Stand 37 Trendz	400	2100	100	110
Wall 47 Trendz	400	2100	100	110

Windpro Series				
Model	SWEEP Size (MM)	SPEED (RPM)	AIR DELIVERY (CMM)	Power Consumption (Watts)
Desk 60	400	1350	100	80
Stand 70	400	1350	100	80
Wall 80	400	1350	100	80
Wall 50	400	2250	100	110

Thunderstorm Series				
Model	SWEEP Size (MM)	SPEED (RPM)	AIR DELIVERY (CMM)	Power Consumption (Watts)
18 Thunderstorm Stand Fan	450	450	150	80
18 Thunderstand Wall Fan	450	450	150	80
24 Thunderstorm Stand Fan	600	600	300	170
24 Thunderstorm Wall Fan	600	600	300	170

Pedestal Fan				
Model	SWEEP Size (MM)	SPEED (RPM)	AIR DELIVERY (CMM)	Power Consumption (Watts)
Tornado II	450	1325	110	90
Stand 34	400	2100	84	58
Stand 31	400	1330	84	58
Stand 32	400	1330	84	58

## PRODUCT COMPARISON

Stand 39	400	1330	84	58
Stand 33	400	1330	84	58
Finstar (Pedestal)	400	1330	84	58
Stand 37	400	2100	100	110
Stand 38	450	2100	87	64
Farata Ft-01	500	1400	167	160
Stand AC 18	450	1400	135	100
Stand AC 24	600	1375	250	200
<b>Table Fans</b>				
<b>Model</b>	<b>SWEEP Size (MM)</b>	<b>SPEED (RPM)</b>	<b>AIR DELIVERY (CMM)</b>	<b>Power Consumption (Watts)</b>
Finstar (Desk-21)	400	1330	84	58
Desk 25	40	1330	84	58
Desk 26	400	1330	84	58
Desk 71	400	1330	84	58
Table 27	400	2100	100	110
Desk 17	300	2100	80	90
<b>Wall Fans</b>				
<b>Model</b>	<b>SWEEP Size (MM)</b>	<b>SPEED (RPM)</b>	<b>AIR DELIVERY (CMM)</b>	<b>Power Consumption (Watts)</b>
Wall AC 18	450	1400	135	100
Wall AC 24	600	1375	250	200
Wall 14	300	2100	80	90
Finstar (Wall)	400	1330	84	58
Wall 41	400	1330	84	58
Wall 43	400	1330	84	58
Wall 44	400	1330	84	58
Wall 47	400	2100	100	110
Wall 49	400	1330	84	58
Wall 11	300	1400	50	53
Wall 48	450	1330	87	64
Tornado Wall II	450	1325	110	90
<b>Multi-Utility Fan</b>				
<b>Model</b>	<b>SWEEP Size (MM)</b>	<b>SPEED (RPM)</b>	<b>AIR DELIVERY (CMM)</b>	<b>Power Consumption (Watts)</b>
Roto 53	400	1330	84	58
Zippy (High Speed)	225	2500	16	50
<b>Stylus Series</b>				
<b>Model</b>	<b>SWEEP Size (MM)</b>	<b>SPEED (RPM)</b>	<b>AIR DELIVERY (CMM)</b>	<b>Power Consumption (Watts)</b>
Stylus Stand	400	1350	100	80
Stylus Wall	400	1350	100	80
<b>Exhaust Fans</b>				
<b>Model</b>	<b>SWEEP Size (MM)</b>	<b>SPEED (RPM)</b>	<b>AIR DELIVERY (CMM)</b>	<b>Power Consumption (Watts)</b>
Smart Air	100, 1500	2400, 1800	90, 240	18, 24
Spring Air	225, 300	1300, 1300	650, 1290	55, 68
Ventilator DX	150, 200, 250	1350, 1300, 1270	280, 550, 780	38, 40, 40
Ventilator HS	150, 200	2500, 2100	500, 750	40, 40
Smart Air Neo	150	2000	250	40
Smart Air LSH	150	2000	230	40
Smart Air Neo SF	150	2000	250	40
Vento Air, Vento Air WF	150	2000	280	40
Ventilator HS	150	2500	500	40
Hill Air	225, 300	1350, 1300	550, 1290	42, 67
High Speed Exhaust	225	2250	1150	60
Air flow	150, 225, 300	2600, 1350, 1300	400, 550, 1290	36, 38, , 50
Power flow	150, 225, 300	2600, 1350, 1320	500, 865, 1800	40, 48, 72
Heavy Duty Exhaust	300, 380, 450, 450, 600	1400, 1400, 900, 1400, 900	1750, 3500, 3900, 6200, 10000	85, 150, 145, 375, 500
Raffa	150, 200	1300, 1280	210, 430	24, 28

Area	Updated Address and contact Details
Kerala	Mr. Manoj Ambady, Orient Electric Limited, 5th Floor, Kallamkuzi Business Square, Ernakulam, Kerala Vyttila, Cochin-682019, Contact No: 918129821355
Chennai	Mr. Vishnu Kumar, Orient Electric Limited.heavitree, 2nd Floor, Unit B, New No. 47, Spur Tank Road, Chetpet, Chennai-600031, Tamilnadu, Contact No: 919600001639
Madurai	Mr. K. Prakash, Rodco Marketing Pvt Ltd, 228, Lig Colony, K.k Nagar Madurai - 625020, Contact No: 9944484128
Hydrabad	Mr. Durgaprasad Rao Orint Electric Ltd, 6-3-1090/Crk Plaza 2nd Floor, Raj Bhavan Road, Somajiguda, Hyderabad - 500082, Telangana (India) Contact No: 9000134193
Banglore	Mr. Kuldip Pandey, Orient Electric Ltd, C/O, Rpm Logistics Pvt Ltd. Sy No. 73, Harokyanthanaha, Dasanapura Hobli, Makali (P) Tumkur Main Road Bengaluru - 552162, Karnataka, Contact No: 9919003378
Vijayvada	Mr. P. Babu, D.no: 23-17/1, Warehouse 1, Kohinoor Estates, Opp Hill Limited, Vijayawada, Mylavaram Rd, Kondapalli, Ibrahimpatnam - Andhra Pradesh, 521228, Contact No. 9052211336.
Delhi	Mr. Vivek Sharma, Rajent Enterprises 3/15, Asaf Ali Road. New Delhi-110002, Mob. 9999410680
Haryana	Mr. Sourav Singh/ Mr. Neeraj Yadav, Alok Distributors, 14/3, Mathura Road, Behind Pnb Bank, Mewala Maharajpur Metro Station, Harayana. Contact No: 96676 00151/9643001001
Rajasthan	Mr Rr Chowdhary / Mr Sunny Sambharwal, Rajasthan,Vasundhara International, D-2(B) Meera Marg,Kamal Varndhavan, Bani Park, Rajasthan- 302016, Contact No: 9001298204/76656 99996
Noida	Mr. Ramit Bhatnagar, D-209, Sector-63, Noida 201301 India, Contact No: 9971397635.
Lucknow	Mr. Sunil Srivastava, Orient Electric Limited-A Ck Birla Group Company, 607, 6th Floor, Ratan Square20-R Vidhan Sabha Marg, Lucknow - 226001, Contact No:9554338866.
Chandigarh	Mr. Dinesh Trehan, Orient Electric Limited, Sco 840 1st Floor, Pac Manimajra, Chandigarh-160101, Contact No: 9646009593.

Area	Updated Address and contact Details
Amritsar	Mr Lalit Chopra, Daga Co, C-4 , Baba Budha Ji Avenue, Opp Ashok Vatika Public School, New Amritsar - 143006, Contact No: 8556978996.
Mumbai	Mr. Vishal Neb: 9769208629 Paramount Logistrade Centre C/O Hellmann Worldwide Logistics Gala No 8 To 13, Building No. A-9, Situated At Survey No 12,Village Lonad, Thane - 421302 Maharashtra.
Pune	Mr. Vishal Neb: 9769208629 , Pune Orient Electric Ltd Sai Balaji Warehousing Gate No.173, Wade Bolhai Road Vill- Kesnand, Tal- Haveli Dist -Pune -412207.
Nagpur	Mr. Deepak Suroshe, Orient Electric Limited, Block No 402, 4th Floor, Shriyash Heights, Plot No. 95, Lendra West Precinct, Ramdaspath, Nagpur - 440010, Contact No: 9158998211.
Indore	Mr. Rajeev Dwivedi , Jalan Brothers Pvt Ltd 4/1, Mangal Compound, Behind Mercedes-Benz Showroom, Dewas Naka, Indore, Pin Code # 452010, Contact No: 9826724892 .
Raipur	Mr. Jay Prakash, Jalan Brothers Pvt. Ltd., Kedia Business Park, Opp. National Garage G.e. Road, Tatiband, Raipur, Contact No: 9131875970.
Ahemdabad	Mr.jaypalsinh Chauhan (M) 9909909272 Orient Electric Limited-A Ck Birla Group Companyopp- Sumar Logistic Park, Gr Floor, Building No 1, Rudra Pratap Logistic Park, Survey No 102-2, Kajipura Ph-64, Matar Industrial Area, Kheda, Gujarat - 387530
Kolkata	Mr. Mayank Kharkwal, 234/3a, Fmc Fortuna Building, 4th Floor, Room No A 10, Kolkata 700020 Contact No: 9839001094.
Bhubaneswar	Mr. Abhinav Batra ,Badhanpur, Puri By Pass Road, Bhubaneswar 751002, Contact No: 9826343332.
Patna	Mr. Raj Anand, Orient Electric Limited - A Ck Birla Group Company 4th Floor, Sai Tower, Beside Hotel Utsav, New Dak Bunglow Road, Patna 800001, India, Contact No: 9386741195
Ranchi	Anand Kumar, Jharkhand Orient Electric Limited, Office No. 401, Modi Heights, Phase-1, Ratu Road, Ranchi-834001, Contact No: 7366965555.
Guwahati	Mr. Manas Jyoti Bharadwaj, Branch Sales Manager, Orient Electric Limited, Nilakshi Talukdar Campus, Opp Vodafone Head Office, Bh-37, Katabari Guwahati 781035, India, Contact No: 9864058464.

OUR OFFICES

SERVICE BRANCH OFFICES

HEAD OFFICE

**Delhi**

Orient Electric 62, 1st Floor,  
Okhla Industrial Estate, Phase-3,  
New Delhi-110020

**Indore**

No 419, 4th Floor, Shagun Sterling  
Plot No 7 PU 4 SCH-54, Vijay Nagar,  
Square Indore-452010

**Kolkata**

6 Ghore Bibi Lane, Phool Bagan,  
Kadapara, Kankurgachi, Kolkata,  
West Bengal-700054

**Chennai**

Heavitree, 2nd Floor, Unit - B, New No: 47,  
Spur Tank Road, Chetpet, Chennai - 600031,  
Tamil Nadu.

**Ahmedabad**

Orient Trading Company, 327, Ratna Business Square,  
Opp. Kunal Restaurant, Ashram Road, Ahmedabad-380009,  
Mob - Jaypalsinh Chauhan - 9909909272

Customer Care No.: 1800 103 7574 (Toll-Free)

Room Size (sqft)	Recommended Sweep Size for Ceiling Fans		
	mm	feet	inches
Upto 70	600	2.0	24
70	900	3.0	36
100	1050	3.5	42
160	1200	4.0	48
180	1300	4.3	52
225	1400	4.7	56

**Important:** To maximize air delivery over the required area, your Orient Electric ceiling fan should be 2.1 meter or more from the ground and 30cm or more below the ceiling. For large rooms with more than one fan, the center distance between each fan will depend on sweep sizes.

Sweep	1400mm	1200mm	1050mm	900mm
Center Distance	3m	2.5m	2m	1.8m

- Visuals shown in the brochure, may vary slightly from actual product
- All ceiling fans are with double ball bearing
- Air delivery may vary  $\pm 5\%$
- All specifications are subject to change without any prior notice
- Models may change during the year

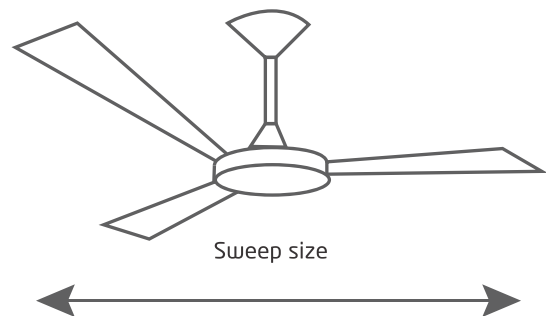

Sweep size is referred to the entire diameter of a fan.



Fans

Lighting

Home  
Appliances

Switchgear

**Orient Electric Limited (a CK Birla Group company)**

240, Okhla Industrial Estate, Phase-III, New Delhi - 110020.

Orient Helpline No.: 1800 103 7574 (Toll Free)

Email: [customer.connect@orientelectric.com](mailto:customer.connect@orientelectric.com)

Website: [www.orientelectric.com](http://www.orientelectric.com)

< BACK

